

Article number: 54301308

Description: LDK Rod end PHS 8

Measures

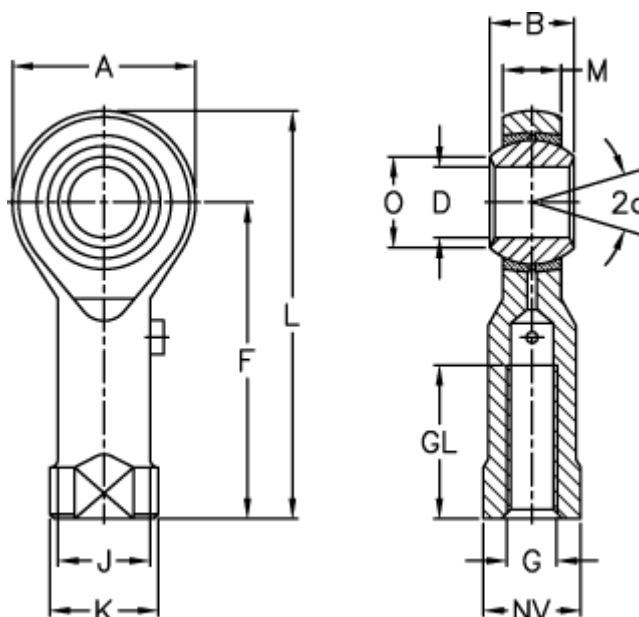

A	= 22	J	= 12.5
a (degrees)	= 14	K	= 16
B	= 12	L	= 47
D	= 8	M	= 9.00
Dynamic load C (kN)	= 5.4	NV	= 14
F	= 36	O	= 10.30
g	= M8	Static load C0 (kN)	= 14.5
GL	= 17	Weight (g)	= 43.0